

Bottle Jacks

2-110 Ton
Portable
hydraulic power

Industrial lifting and pushing applications.

JACKS



- Choose from this complete line of premium-quality, standard bottle jacks. Ideal for use in any number of industrial lifting and pushing applications.
- The 9110B, 9015B, 9022B and 9033B feature a beveled base which allows the jack to "follow" the load, reducing the chance of dangerous side-loading.
- Many jacks feature screw extensions and all can be used in the vertical, angled or horizontal positions.
- Serrated or contoured saddles help stabilize the load for a safer lift.
- All jacks meet ASME B30.1 standards and carry the Power Team Marathon Lifetime Warranty.
- 110-ton jack features dual pumps for time-saving two-speed operation.

ORDERING INFORMATION

Cap. Tons	Stroke (mm)	Order Number	Retracted Height Min. (mm)	Length of Screw Ext. (mm)	Height w/Screw Ext. (mm)	No. Pump Strokes to Ext. Piston completely	Saddle Dia. (mm)	Base Size (mm)	Pump Handle Length (mm)	Handle Effort at Rated Cap. (kg)	Carry Handle	Metric tons at 700 (bar)	Product Weight (kg)
2	114	9002A	181	49	344	5	25	110x65	311	34	No	1,8	2,2
3	114	9003A	191	60	365	10	29	114x72	489	20,4	No	2,7	2,6
5	121	9005A	200	70	391	12	35	132x76	545	24,9	No	4,5	3,6
8	121	9008A	200	70	391	18	38	152x89	605	34	No	7,3	5,5
12	149	9112A	241	79	470	26	48	165x106	605	27,2	Yes	10,9	7,9
15	156	9015B	230	110	495	27	60	130x140†	700	40,8	No	13,6	8,3
20	159	9120A	270	40	429	22	51	183x129	800	31,7	Yes	18,1	12,9
22	156	9022B	240	110	505	36	60	165x160†	700	40,8	Yes	20,0	10,7
30	159	9030A	279	—	438	35	60	192x141	1.000	22,7	Yes	27,2	18,7
33	143	9033B	240	100	483	56	65	184x176†	700	39,9	No	29,9	14,5
50	171	9050A	305	—	476	35	76	237x187	1.000	38,6	Yes	45,4	35,4
110	156	9110B	300	—	456	40/160‡	111	339x291	700	35,8	Yes	99,8	70

† Comes with a Beveled Base

‡ 2 Speed: Rapid advance=40 strokes; Lift mode=160 strokes

Low Profile BOTTLE JACKS

12, 20 & 30 Ton

The right choice for those
lower clearance jobs.



- All the quality, features and lifting capacity of the standard jacks in short form. The 12-ton and 20-ton models feature screw extensions for added versatility.
- All jacks meet ASME B30.1 standards and carry the Power Team Marathon Lifetime Warranty.
- All jacks operate both vertically and horizontally for use in a variety of lifting, pushing and spreading applications.

ORDERING INFORMATION

Cap. Tons	Stroke (mm)	Order Number	Retracted Height (mm)	Length of Screw Ext. (mm)	Height w/Screw Ext. (mm)	No. Pump Strokes to Ext. Piston (mm)	Saddle Dia. (mm)	Base Size (mm)	Pump Handle Length (mm)	Handle Effort at Rated Cap. (kg)	Carry Handle	Metric tons at 700 bar	Product Weight (kg)
12	95	9012A	171	76	343	26	48	165x106	605	27	Yes	10,9	6,4
20	86	9020A	181	40	305	22	51	183x129	800	32	Yes	18,1	10,1
30	79	9130A	181	—	260	35	60	192x141	1.000	23	Yes	27,2	13,7

† 2 Speed: Rapid advance≈40 strokes; Lift mode≈160 stroke

JACKS

Toe Jacks

5.5, 11 & 27.5 Ton

Get under equipment with only 27 mm of ground clearance.

JACKS



ASME B30.1

- With lifting points on the toe and on the top, these extremely rugged jacks are ideal for machine lifting, rigging, lift truck service and much more.
- Choose from 5.5-ton, 11-ton, and now, an amazing 27.5-ton lifting capacity.
- All jacks operate both vertically and horizontally.
- Base, toe and pumping assembly swivel independently, allowing the jack to work in confined areas.



The J Series Toe Jack is an extremely rugged jack used here for lift truck service.

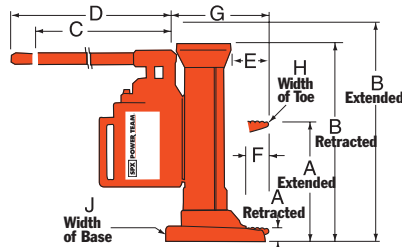

DIMENSIONS

Order Number	A		B		C	D	E	F	G	H	J
	Ret. (mm)	Ext. (mm)	Ret. (mm)	Ext. (mm)							
J58T	30	238	375	584	368	451	71	56	176	41	130
J109T	30	264	419	654	368	451	76	56	183	64	171
J259T	54	289	505	738	210	756	146	102	267	89	270

ORDERING INFORMATION

Cap. Tons	Max Lift Stroke (mm)	Order Number	Strokes to Extend Piston 25,4 mm	Handle Effort at Max Load (kg)	Carry Handle	Metric tons at 700 bar	Product Wt. (kg)
5½	210	J58T	8	38,1	Yes	5,0	19,5
11	235	J109T	13	40	Yes	10,0	29
27½	233	J259T	21	40	Yes	24,9	92,1

Economy TOE JACKS

2, 5 & 10 Ton



Just the power you need at a price you can afford.

JACKS

- These bottle jack-style toe jacks are loaded with many of the same features as our standard bottle jacks, but the toe-lift feature and swiveling pump handle socket make them ideal for machinery lifting and positioning.
- An internal pressure relief provides added safety by limiting the jack's lifting capability to the capacity of the toe.
- Spring return is an added feature on the larger jacks.
- Swiveling pump handle assembly available on the 5- and 10-ton models. The swiveling jack assembly allows you to access and pump the unit from numerous positions.

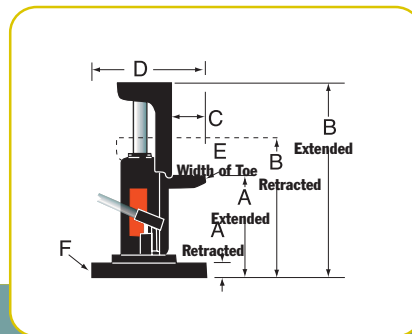

Order Number	A		B		C	D	E	F
	Ret. (mm)	Ext. (mm)	Ret. (mm)	Ext. (mm)				
J24T	16	140	232	356	47,5	181	51	125
J55T	25	149	292	476	47,5	257	191	157
J106T	32	181	327	476	64	292	100	241

ORDERING INFORMATION

Cap. Tons	Max Lift Stroke (mm)	Order Number	Strokes to Extend 25 mm	Handle Effort at Max Load (kg)	Carry Handle	Metric tons at 700 bar	Product Wt. (kg)
2	121	J24T	14	19	Yes	1,8	8,3
5	121	J55T	22	27	Yes	4,5	24
10	146	J106T	31	33	Yes	9,1	38

Bottle Jacks

TELESCOPING

6-15 Ton

These jacks offer greater extended lifting capability.

JACKS



ASME B30.1

- Telescoping jacks offer all of the quality features and capabilities of the standard bottle jack line with a bonus. The super-long stroke of these jacks saves time and effort by eliminating the need to lift, crib, lift, etc. In most applications, the user can place the jack once and complete the lift.
- The 9015X offers very low clearance capability, making it the ideal choice for forklift maintenance or machine lifting.
- The taller 9006X, 9011X and 9013X all feature a unique beveled base that allows the jack to "follow" the load laterally as it is raised, greatly reducing side-loading of the piston.

ORDERING INFORMATION

Cap. Tons	Stroke (mm)	Order Number	Retracted Height Min. (mm)	Length of Screw Ext. (mm)	Height w/Screw Ext. (mm)	No. Pump Strokes to Ext. Piston 25,4 mm	Saddle Dia. (mm)	Base Size Beveled Base (mm)	Pump Handle Length (mm)	Handle Effort at Rated Cap. (kg)	Carry Handle	Metric tons at 700 bar	Product Weight (kg)
6	305	9006X	216	—	521	14	44	121 x 133	700	36	No	5,4	6,4
11	262	9011X	200	68	530	25	41	160 x 165	700	40	No	10,0	8,8
13	254	9013X	230	84	570	35	48	176 x 186	700	36	Yes	11,8	11,3
15	181	9015X	170	70	419	32	52	143 x 194	600	43	Yes	13,6	12

Sidewinder Jacks

MINI JACKS

5-20 Ton

Compact Sidewinder Mini Jack fits in your palm and delivers 5, 10 & 20 tons of lifting force.



- Retracted height of just 63,5 mm for the smallest jack and 130,2 mm for the 20 ton, allows you to slip this jack into the narrowest of crevices.
- The perfect addition to any toolbox, this remarkable little jack has multiple uses that are limited only by your imagination. Use it as a jack or a spreader. Use it to turn your mechanical gear puller (puller capacity must match jack capacity) into a hydraulic puller. Use it vertically or horizontally in limited clearance.
- Jacks operate either horizontally or vertically. Handles function in line with base for easier use in confined spaces.

ORDERING INFORMATION

Cap. Tons	Stroke (mm)	Order Number	Retracted Height Min. (mm)	Max Height (mm)	No. Pump Strokes to Ext. Piston 25 mm	Saddle Dia. (mm)	Base Size Dia. (mm)	Pump Handle Length (mm)	Handle Effort at Rated Cap. (kg)	Carry Handle	Metric tons at 700 bar	Product Weight (kg)
5	19	9105A	63,5	85,7	30	29	73,8	240	26	No	4,5	1,9
5	38	9205A	88,9	130,2	38	29	73,8	240	26	No	4,5	2,4
10	30	9210A	120,7	149,2	36	42,1	109,9	440	28	No	9,1	5,5
20	30	9220A	130,2	160,3	46	52,8	119,9	605	35	No	18,1	8,0

JACKS

Maintenance Sets

Hydraulic system components

JACKS



IM10E



IM10H

APPLICATION FLEXIBILITY

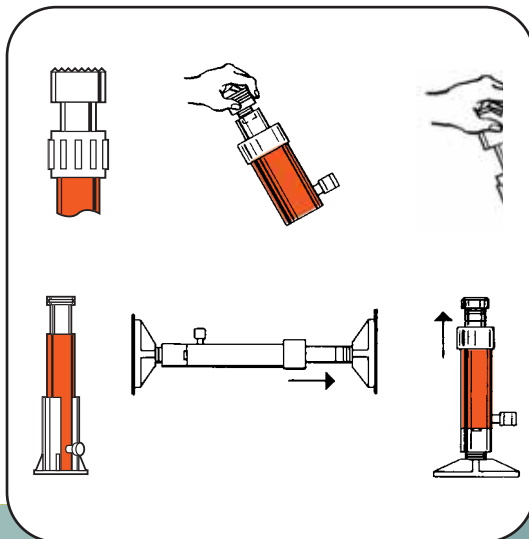

- Matched hydraulic system components, adapters and hydraulic spreader, contained in a rugged carrying and storage case.
- Portable sets are ideal for pushing, pulling, lifting, straightening, or clamping at remote job sites.
- Cylinders in set are rated at 10 tons at 700 bar. Set components are designed for full rated capacity of cylinders.
- Set IM10H includes hand operated pump. Set IM10E includes the Quarter Horse® electrically driven portable power unit.

ORDERING INFORMATION

CONTENTS OF SET NO. IM10E

Description	Order No.
Hydraulic spreader	HS2000
Hand pump (electric)	PE102
700 bar hyd. gauge	9041
Tee adapter	9670
Hose & coupler assembly	9754
90° V base	25395
Threaded coupler	25664
Serrated saddle	31772
Flat base	32325
Extension rod – 127mm length	350897
Extension rod – 254 mmlength	38909
Extension rod – 457 mm length	350898
Cyl. support base	420062
Cyl. ass'y, 10 ton, 257 mm stroke	C1010CBT
Cyl. ass'y, 10 ton, 156 mm stroke	C106CBT
Storage box	350722

Prod. Weight – 48,1 kg.

CONTENTS OF SET NO. IM10H

Description	Order No.
Hydraulic spreader	HS2000
Hand pump	P59
700 bar hyd. gauge	9041
Tee adapter	9670
Hose & coupler assembly	9754
90° V base	25395
Threaded coupler	25664
Serrated saddle	31772
Flat base	32325
Extension rod – 127 mm length	350897
Extension rod – 254 mm length	38909
Extension rod – 457 mm length	350898
Cyl. support base	420062
Cyl. ass'y, 10 ton, 156 mm stroke	C106CBT
Storage box	350722

Prod. Weight – 40,4 kg.

**SJ2010
SJ3010**



**SJ2010DA
SJ3010DA**

Post Tension & STRESSING JACKS

20 & 30 Ton

- Power Team Monostrand Stressing Jacks are the most durable in the industry.
- Ideally suited for work on slab-on-grade where dirt, heat and high volume use take their toll.
- Available in single- or double-acting models.
- Standard single-acting units have a 254 mm stroke. Other stroke lengths are available on special order.
- Dead-end seaters for production work and field work available on special order.
- Service repair is simple; components are long lasting and easily replaced.
- 76,2 mm detachable seater nose assembly easily replaced with optional 152,4 mm nose assembly.
- The jack of choice for high-rise and elevated work, thanks to fast return time and light weight.
- All hydraulic fluid controls are interior designed; more efficient and safer operation during tensioning and retraction.
- Standard double-acting units have an 216 mm stroke; others available on special order.
- Specially designed Power Team Control Valves are available for post tensioning jacks. See pages 51.

JACKS

ORDERING INFORMATION

Description	Cyl. Cap. Tons	Stroke (mm)	Order Number	Recommended Pumps for this Stressing Jack	Oil Capacity (l)	Strand Diameter (mm)	Seater Type	Tons at 700 bar	Weight (kg)
Post tension jack with spring seater, 12,7 mm strand.	20	254	SJ2010	PE554T/PE604T	0,72	11,1-12,7	Spring	20,3	25
Post tension jack with power seater, 12,7 mm strand.	20	254	SJ2010P	PE604PT	0,72	11,1-12,7	Power	20,3	25
Double-acting post tension jack with power seater, 12,7 mm strand.	20	215	SJ2010DA	PE554PT/PE604PT	0,85	11,1-12,7	Power	23,9	19
Post tension jack with spring seater, 15,2 mm strand.	30	254	SJ3010	PE554T/PE604T	1	11,1-15,2	Spring	28,5	34,5
Post tension jack with power seater, 15,2 mm strand.	30	254	SJ3010P	PE604PT	1	11,1-15,2	Power	28,5	34,5
Double-acting post tension jack with power seater, 15,2 mm strand.	30	215	SJ3010DA	PE554PT/PE604PT	1,1	11,1-15,2	Power	36,0	23,5

STRESSING JACK ACCESSORIES AND HOSES—ORDERING INFORMATION

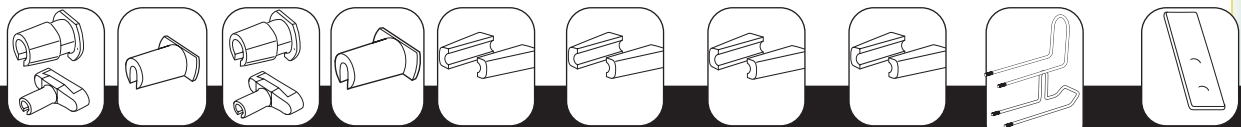

Used with Stressing Jack	76,2 mm Nose Piece	76,2 mm Wedge Seater	152,4 mm Nose Piece	152,4 mm Wedge Seater	9,5 mm Diameter Gripper Set	11,1 mm Diameter Gripper Set	12,7 mm Diameter Gripper Set	15,2 mm Diameter Gripper Set	Replacement Gripper Handle	Gripper Retainer Plate (2 used)
SJ2010	252564	252562	252759	252763	252568	252761	252567	NA	252570	252565
SJ2010P	252564	252562	252759	252763	252568	252761	252567	NA	252570	252565
SJ2010DA	252543	252542	252760	252764	252650	252762	252555	NA	252556	252544
SJ3010	252564	252562	252759	252763	252568	252761	252567	252569	252570	252565
SJ3010P	252564	252562	252759	252763	252568	252761	252567	252569	252570	252565
SJ3010DA	253363	253361	253364	253362	253390	NA	253391	253365	252556	252544

No. 9758E Hose – 3,1 m rubber, wire-braid (2-ply, 2.800 bar burst rating) 3/8" NPTF male hose ends

No. 9763E Hose – 3,1 m rubber, wire-braid (2-ply, 2.800 bar burst rating) 3/8" x 1/4" NPTF male hose ends

TECH DATA

Page 134

Inflatable Jack

1-74 Ton

IJ Series Inflatable Air Jacks



The non-skid space age reinforced inflatable jack is perfect for many applications.

JACKS

- Highly flexible and lightweight jacks only require an air supply of 8 bar maximum. Any non-explosive gas or water can also be used for inflation.
- Uninflated jacks are only 25,4 mm thick, making seemingly impossible lifting tasks routine.
- Space age reinforced, multi-layer aramid construction, widely overlapping on all sides. Tested at 8 bar.
- In rugged testing, jacks withstood tens of thousands of inflate/deflate cycles at 12 bar.
- Large surface area and material flexibility allow jacks to lift loads on soft or compressible surfaces without support cribbing being necessary.
- Safety first! The controller, shut-off and air hoses are all equipped with USA industrial interchange style air couplers. Female half coupler bodies have a locking collar, protecting operator from accidentally disconnecting jack while under load.
- Surface of jack has a non-skid pattern, assuring that the jack won't "walk away" from the job. Jacks can be used to lift a load from an uneven surface, are tolerant of side-loaded applications.
- Non-conducting material resists oil, ozone and most chemicals. Cold resistant down to -40° C, heat resistant up to 115°C(short term) or 93°C(long term).
- Field-replaceable nipples are made of tough steel, with internal thread to prevent abrasion damage. Ideal needle aperture of 6,4 mm allows rapid inflation, without risk of icing, and permits a safe lowering speed.
- Single jack controller with "dead man" control (350090). Can be used individually, or in multiples to regulate any number of jacks desired.
- Heavy attachment straps are provided on 4 largest sizes for attachment of a rope or hook to position the jack from a safe distance.
- Inflation hose system is color-coded (red and yellow) for easy recognition when using more than one jack.

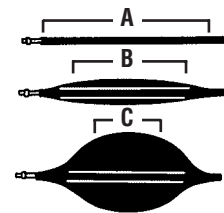

Maximum Effective Lifting Area

All lifting capacities mentioned in the charts are measured at the maximum effective lifting area (A). As the jack is inflated (B), this effective area decreases (C) due to the rounded shape of the jack. Lifting capacity also decreases (see performance chart).

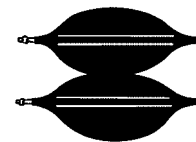

Stack up to two jacks together to increase effective lifting height.

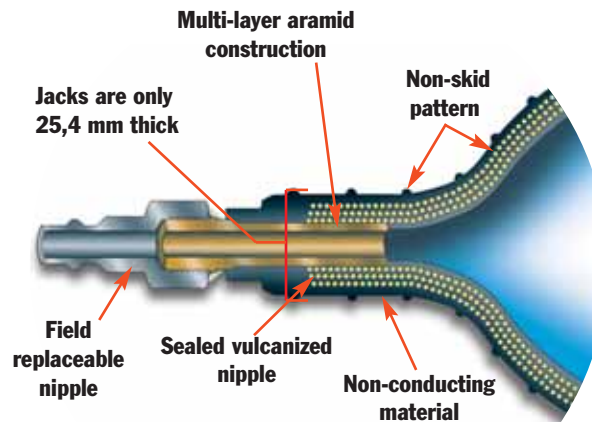

*** NOTE: 350090 air controller may be used individually to control one jack (see single line system), or in multiples to control additional jacks (see dual line system).**



No. 307159 – Pressure reducing valve. Allows use of bottled gases to operate jacks (works on CGA-580 Nitrogen/Argon/Helium bottles). Contains standard bottle fitting on inlet and 1/4" industrial interchange (female) outlet. Wt., 1,8 kg.

No. 350090 – Air controller for single jack. Equipped with relief valve and pressure gauge.

No. 350207 – Shut-off hose with shut-off valve and pressure relief valve. Includes a female and male quick coupler.

No. 350208 – Air hose. Red, 9,2 m long. Includes No. 250341 female and No. 250342 male quick coupler.

No. 350209 – Air hose. Same as 350208, except blue in color.

No. 250343 – Female quick coupler. 1/4" industrial interchange x 1/8" NPT female. Wt., 0,1kg.

No. 250353 – Male quick coupler. 1/4" industrial interchange x 1/8" NPT male. Wt., 0,1 kg

No. 250682 – Female quick coupler. 1/4" industrial interchange x 1/4" NPT male. Wt., 0,1 kg.

No. 15235 – Connector 1/8" NPT male x 1/4" NPT female. Wt., 0,1 kg

No. 250341 – Female quick coupler. 1/4" industrial x 9,5 mm I.D. hose.

No. 250342 – Male Quick coupler. 9,5 mm I.D. Hose.

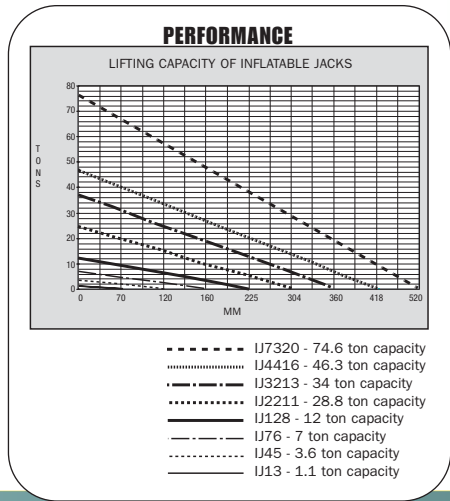
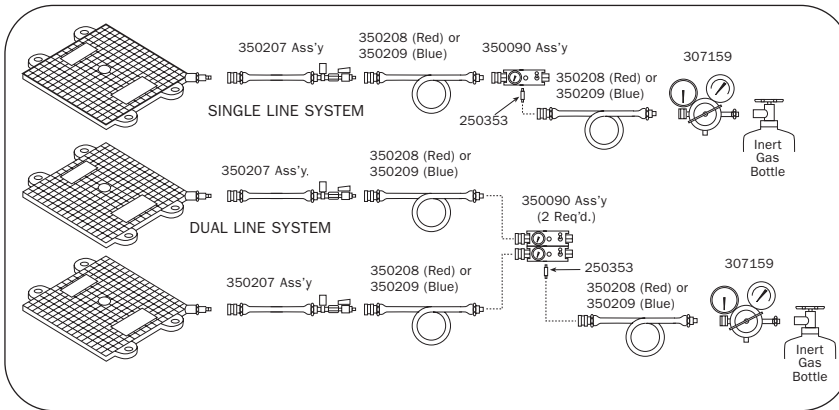

ORDER INFORMATION								
Lifting Cap. (tons)	Lifting Height (mm)	Order Number	Air Contents at 8 bar (l)	Max. Working Pressure (bar)	Length (mm)	Width (mm)	Collapsed Height (mm)	Product Weight (kg)
1,1	70	IJ13	2,3	8	140	130	25,4	0,5
3,6	120	IJ45	14,4	8	255	200	25,4	1,2
7	160	IJ76	42	8	305	305	25,4	1,9
12	225	IJ128	97	8	400	400	25,4	3,6
23,8	304	IJ2211	268	8	550	550	25,4	7,3
34	360	IJ3213	463	8	650	650	25,4	9,9
46,3	418	IJ4416	729	8	750	750	25,4	13,1
74,6	520	IJ7320	1.457	8	950	950	30,4	26,3

Portable HIGH TONNAGE JACKS

60-100 Ton Railroad Edition

Portable & compact, ideal for locomotive and railcar maintenance.

JACKS

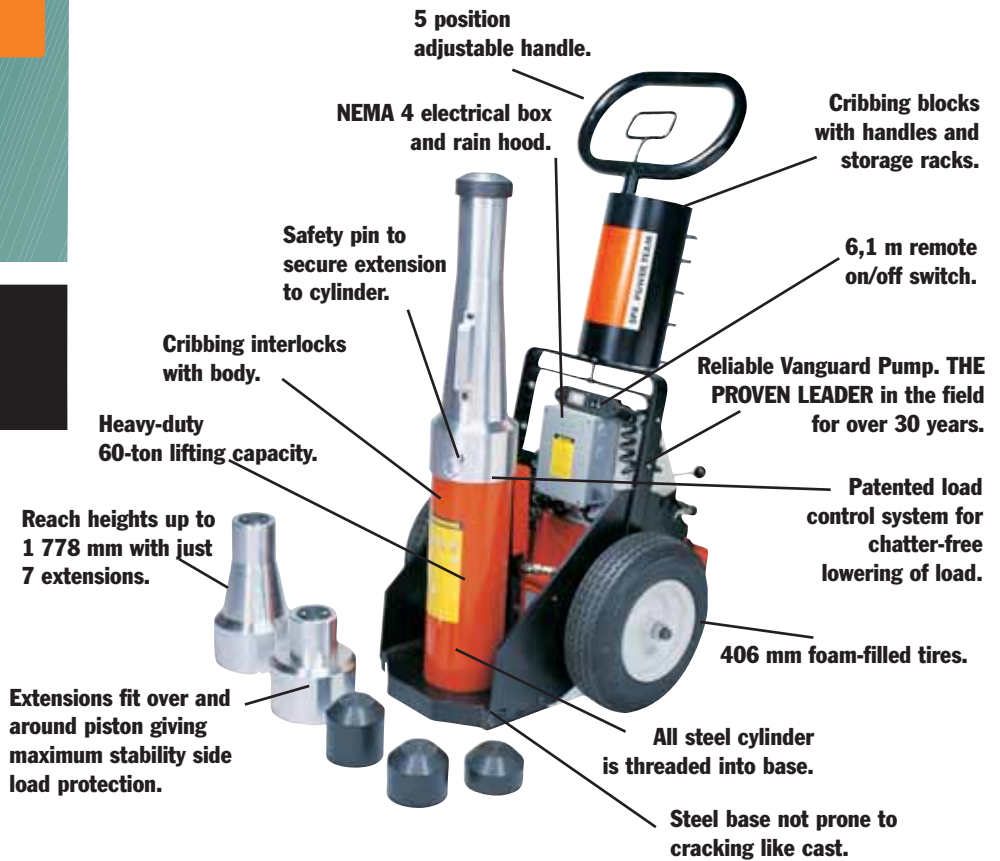

- Patented load lowering valve. Lowers load smoothly and safely. Eliminates dangerous chatter and bounce.
- Full range of rod extensions. Jack comes fully equipped with extensions to match lifting pad heights on most rolling stock. Max. lifting height to 1 778 mm .
- Low collapsed height, long stroke. 610 mm collapsed height for low-clearance lift pads. 360 mm stroke for maximum lift.
- Adjustable, ergonomic handle. Handle tilts to start the job and is easily locked/unlocked without moving from operating position.
- NEMA 4 electrical box and rain hood. Pump motor and controls protected from water. Quiet operation.
- Cribbing block set with handles and convenient storage rack. Provides solid mechanical load holding.
- High-profile, low rolling resistance, foam-filled tires. Jack can be moved and positioned with minimal effort. No chance of downtime due to punctured tires.
- Electric and air motor options. Quiet, powerful air and electric motor powered units available.

POWER UNIT SPECIFICATIONS

Order No.	Motor	Power Req.	Motor Control	Valve Function	Power Cord	dBa at 700 bar
PLE6014-220	0,84 kW, 220 VAC***, 50 Hz Single Phase	12 amps	6,1 m Remote Control	Lift Hold Lower Manual	Pigtail	80/95
PLA6014-220	Rotary Air Powered	1,4 cu.m at 6 bar	6,1 m Remote Air Control	Lift Hold Lower Manual	NA	82

*** For 110/115V-50/60 Hz order PLE6014

**Electric Model
(PLE6014)**



**Air Model
(PLA6014)**



**CRIBBING BLOCKS
(CBS60, INCLUDED)**

Qty.	Height (mm)	Order Number
1	38,1	351954
4	76,2	351953

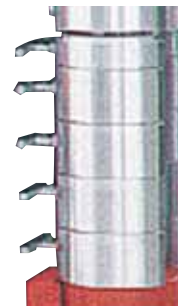

**EXTENSIONS
(PL60 EXT, INCLUDED)**

Extension Length (mm)	Order Number	Extension Weight (kg)
25,4	351931	2,2
50,8	351927	4,0
76,2	351928	6,4
101,6	351929	8,7
127	66053	9,5
254	66054	13,8
508	66055	22,1

LIFTING RANGE

Lifting range (in 25,4 mm increments): 610 mm- 1.778 mm.

Only 3 extensions are needed to provide this range.

Do NOT exceed 1.778 mm lifting range on 60-ton unit or 1.489 mm on 100-ton unit.

ORDER INFORMATION

Capacity (Tons)	Stroke (mm)	Order Number	Retracted Height (mm)	Extended Ht. w/Extensions (mm)	Product Wt. Less Cribbing & Ext. (kg)
60	356	*PLE6014K	610	1.778	237
60	356	*PLA6014K	610	1.778	237
60	356	*PLE6014K-220	610	1.778	237
100	356	Consult Factory	610	1.499	237

*Includes cribbing block set stored on jack handle rack, and 7 extensions (25,4; 50,8; 76,2; 101,6; 127; 254 and 308 mm)

PLE6014 = Jack, Electric, includes: Cart, Pump & Cylinder

PLE6014-220 = Jack, Electric (220 V.)

PLA6014 = Jack, Air, includes: Cart, Pump & Cylinder

CBS60 = Cribbing Block Set (5 cribbing blocks)

PL60EXT = Extension Set (Consists of 7 extensions)

Portable HIGH TONNAGE

55, 100 & 150 Ton

Portable and compact, ideal for locomotive/railcar, mining and heavy equipment maintenance.

JACKS

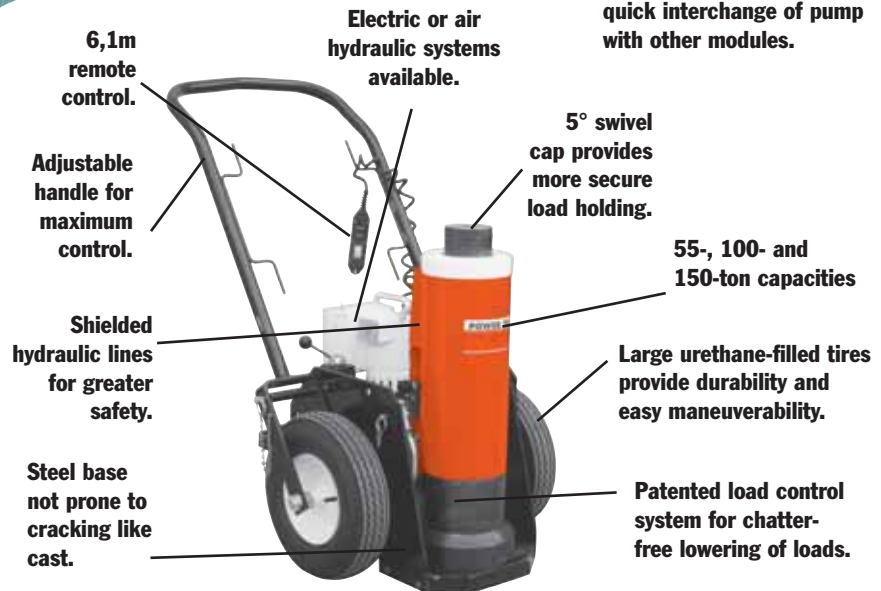

- Modular design - pump and cart separate from cylinder and base.
- Three tonnage capacity options - 55-ton, 100-ton and 150-ton.
- Three collapsed height options – 660, 838 and 1,143 mm.
- Two standard power options - air (PA55) and electric (PE55).
- Two control options - remote motor control and remote valve/motor control.
- Accessory options – 168 mm extension, load-holding rings.
- Select the collapsed height to fit your most frequent application - add jacking modules to suit your needs.
- Remote operation for maximum operator safety and control - choose "motor only" or "motor and valve" control in the hand.
- Easy to maneuver - large tires and small "footprint" make it easy to scoot into the tightest quarters, then locate the exact lifting position.
- Adjustable, heavy-duty handle - makes this jack easy to move, position under vehicles. Can also be used to transport jack on site with a forklift.
- Load-holding rings (optional) - provide full rated mechanical load-holding capability.
- Cylinder extension (optional) - adds more versatility by extending your jack's reach.
- Low-temperature oil (optional) - provides smooth, reliable operation in the coldest climate conditions.
- Modular design - allows you to change lifting modules to suit your tonnage or height requirements. Use the pump module as a portable power station for your other double-acting cylinders (700 bar).
- Exclusive load-control system - provides positive, chatter-free control when lowering the load.
- Shielded and sheltered hydraulic lines - for safer, longer, trouble-free service.

ORDER INFORMATION

CRIBBING BLOCK SETS - INCLUDES ONE JACK MODULE EXTENSION

Order No.‡	55 Ton CBS55		100 Ton CBS100		150 Ton CBS150	
	No. in Set	1	4	1	4	1
A	38,1	76,2	38,1	76,2	38,1	76,2
B	44,5	82,5	44,5	82,5	44,5	82,5
C	139,7	139,7	187,3	187,3	222,2	222,2
Jack Module Ext.	173		177,8		168,3	
Total Stack Ht.	515,9		520,7		511,2	
Product Wt. (.kg)	16,3		30,9		38,6	

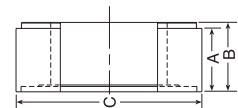

- Convert jack module into stable mechanical cribbing device.
- Increase retracted height up to 521 mm inches.

ORDER INFORMATION

JACK MODULE EXTENSIONS

(Tons)	No.	A (mm)	B (mm)	C (mm)	D (mm)	E (in.)	F (mm)	G (mm)	H (mm)	Prod. Wt. (kg)
55	58945	223,8	173	127	66,8	1 ¹¹ / ₁₆ -8UN	63,5	66,8	92,2	9,5
100	58943	228,6	177,8	174,7	98,6	2 ³ / ₄ -12UN	95,3	98,6	95,3	18,2
150	58944	219,2	168,4	203,2	114,3	3 ¹ / ₄ -8UNC	111,3	114,3	88,9	22,7

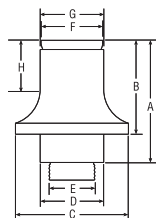

- Increases jack's reach.
- Swivel cap (5° max.) provides more secure load holding.



Pump & cart modules

Pump and cart modules contain hydraulic pump, cart, remote control and all hoses and fittings required to connect to a jack module. Jack modules easily separate from the pump and cart module. Extra jack modules may be purchased for a wide variety of lifting applications.

Remote Control		
Pump	Motor Only	Motor & Valve
Air	PMA55	PMA55S
Electric	Consult Factory	PME55S



Air pump and cart module.



Electric pump and cart module.



660 mm Jack Module



838 mm Jack Module



1.143 mm Jack Module

Jack modules

Additional Jack Modules may be purchased for varying applications.

Tonnage	Collapsed Height (mm)		
	55	JM25	JM35
100	JM210	JM310	JM410
150	JM215	JM315	JM415

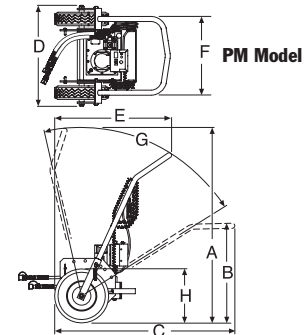
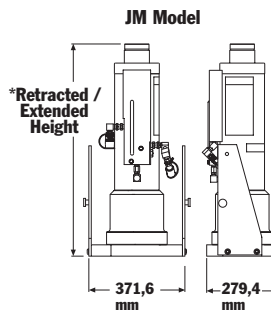

DIMENSIONS (MM)

Model Series	A	B	C	D	E	F	G	H
PMA & PME	1.464	752	1.353	762	872	594	*70°	406 mm

* Total range with varying degree increments. Tire Dia.

ORDER INFORMATION – Pump and Cart Modules with Assembled Jack Module

Capacity (tons)	Ret. Height (mm)	Ext. Height (mm)	Stroke (mm)	Pump Type	Power Required	Valve Type	Remote Control	Order No.
55	660,4	994	333	Electric	25 amps	Manual	M	JEM5526
100	838,2	1.172	333	Air	1,4 cu m /min at 6 bar	Manual	M	JAM10033
100	838,2	1.172	333	Air	1,4 cu m /min at 6 bar	Air Pilot	M & V	JAR10033
150	660,4	994	333	Electric	25 amps	Manual	M	JEM15026
150	838,2	1.172	333	Air	1,4 cu m/min at 6 bar	Manual	M	JAM15033